

Safety and Bunging Valves
Tank Dome Fittings
Aseptic Sample Valve

Tanks



We do everything – for your safety

There are many reasons for an excessive rise of pressure in closed systems which may arise specifically or simultaneously. If process monitoring and control systems fail, safety valves provide the only effective protection for vessels and pipelines against serious damage, until the original operating conditions are restored.

KIESELMANN offers a wide range of different safety components for all mediums, whether it's a liquid or gas. The counselling of the KIESELMANN specialists, who have many years of experience, and a special software give you the assurance that the selected components are carefully designed for the specified process and reliably protect.

Of course, our safety valves are tested and approved by the TÜV (Technical Control Board in Germany) and comply with the valid standards, rules and regulations. Each safety valve is individually calibrated in our test centre and then leaded. A corresponding test certificate accompanies each delivery.

We do everything – for your safety.



Safety valve in the KIESELMANN test centre

The KIESELMANN Safety Programme

KIESELMANN Safety Fittings

- ▶ For liquids and gases
- ▶ Tested and approved by TÜV according to PED 97/23/EG
- ▶ Design, production and function conform to AD 2000 Guidelines
- ▶ Excellent blow-off performance (high flow coefficient) with low flow resistance
- ▶ Hygienic design
- ▶ CIP/SIP cleanable



Protection against inadmissible overpressure

KIESELMANN safety valves operate automatically, without any auxiliary energy, as soon as system pressure exceeds the adjusted set point. They are characterized by very precise response performance along with excellent flow capacity.

The safety valves are designed with a compact and closed housing. All moving parts are kept inside. On the one side it allows a proper cleaning of the outer surfaces, on the other it avoids the risk of an external blocking. The spherical shaped cavity with the hygienic designed clamp connection ensures excellent CIP/SIP performance at any time.

Basic configurations

- ▶ Spring return
- ▶ Weight loaded

Optional features

- ▶ Position sensor
- ▶ Manual easing gear
- ▶ Pneumatic easing gear



Safety valves for gases (spring return)



Safety valve for liquids and gases (spring return and weight-loaded)

TECHNICAL DATA

Nominal widths:	DN 25–100 (liquids and gases) DN 20 (gases)
Materials:	1.4301 / AISI 304 1.4404 / AISI 316L for all product wetted parts
Seal materials:	EPDM, HNBR, Viton, FKM
Set pressure:	0.2–12 bar depends on nominal width (liquids) 0.1–10 bar (gases)
Operating temperature:	max. 90° C (liquids) CIP/SIP capable up to 140° C max. 130° C (gases)
Standard connection variants:	Taper nut DIN 11851 (liquids) G 1 taper nut DIN 11851 (gases) other connections upon request (e. g. flanges, clamps)
Options:	manually or pneumatically liftable heatable (liquids) Sensor inductive (liquids) cleaning hood (gases)

Constant pressure ratios

These bunging valves with spring return are continuously adjustable.

Exactly adjustable to the desired opening pressure. The valves are closed and opened very sensitively with low differential pressures.

The KIESELMANN bunging valves are available both in open design (free blowing-off of CO₂) and in closed design with pipe connection. The closed design enables to collect the excess CO₂.



Bunging valve Type 6268 (spring return)



Bunging valve on a KZE for beer

TECHNICAL DATA

Nominal widths:	G 1, DN 15*, 25*/32, 40 and 50
Materials:	1.4301/AISI 304 1.4404/AISI 316L for all product wetted parts
Seal materials:	Viton, EPDM
Set pressure:	0,2–4 bar (Type 6268) 0,2–3,2 bar (Type 6255)
Standard connection variants:	Taper nut DIN 11851, G 1 other connections upon request (e. g. flanges, clamps)

*Approval for gases according to DGRL (PED)



Bunging apparatus Type 6255 including function for safety (spring return)

Pressure Compensation Valves

Pressure compensation

A multitude of vacuum and pressure compensation valves are available for further applications.

Our application consultants will be pleased to help you to choose the appropriate valve.

In order to guarantee the vessel safety, an additional safety valve is necessary, as for this is characterized by a blow-off performance defined for critical situations and by a operating point fixly adjusted.



Pressure compensation valve
(spring return)
Type 6132



Pressure compensation valve
(spring return)
Type 6133



Pressure compensation valve
(spring return)
Type 6135



Pressure compensation valve
(spring return)
Type 6131



Pressure compensation valve on top of a tank

Vacuum Protection

KIESELMANN anti-vacuum valves provide very precise response characteristics and excellent flow capacities. The hygienic design offers a perfect cleanability of the sealing and seat area. Moreover, it shows outstanding leak tightness, even at very low operating pressures.

Referring to specific applications, the anti-vacuum valves are available in different sizes and designs, e. g. with counter weight, spring return or compact design.

They can be installed individually as single items or in combination with tank top units.

Additional features:

- ▶ Electric trace heater set
- ▶ Pneumatic lifting device
- ▶ Position sensor



Anti-Vacuum valve
(spring return)
Type 6139



Anti-Vacuum valve
(spring return)
with position sensor
Type 6160



Anti-Vacuum valve
(spring return)
Type 6160

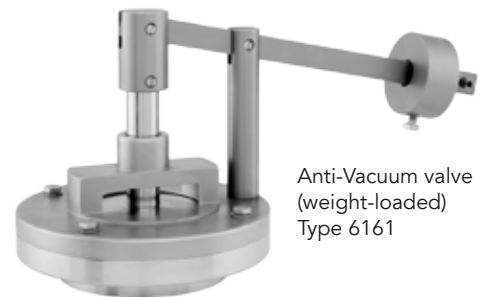

Anti-Vacuum valve
(weight-loaded)
Type 6161

TECHNICAL DATA

Sizes:	DN 50–250
Materials	
Flange of housing:	1.4301 / AISI 304
Valve disk:	1.4301 / AISI 304
Shaft:	1.4301 / AISI 304
Compression spring:	1.4315 / AISI 304N
Seal materials:	EPDM (disk) VMQ (flange of housing)
Factory set pressure:	3 mbar (30mmWS)
Operating pressure:	up to 16 bar (depends on nominal width)
Operating temperature:	max. 95° C

Tank Dome Fittings

Overpressure Protection, Vacuum Protection, CO₂ Recovery and Tank Cleaning

Four functions covered by single equipment. The KIESELMANN tank top unit takes up all required equipment and ports with only one connection port to the vessel. CO₂ recovery and CIP supply will be managed by an integrated change-over valve. During CIP the cleaning agent will pass through the unit and the attached tank cleaning device. Small spray nozzles inside the unit ensure an effective cleaning of the wetted surfaces with a minimized cleaning agent consumption. Safety valve and anti-vacuum valve are directly mounted to the tank top unit.

Additional process equipment, such as bunting valves, gauges, fittings and other items may be installed in the connected piping.

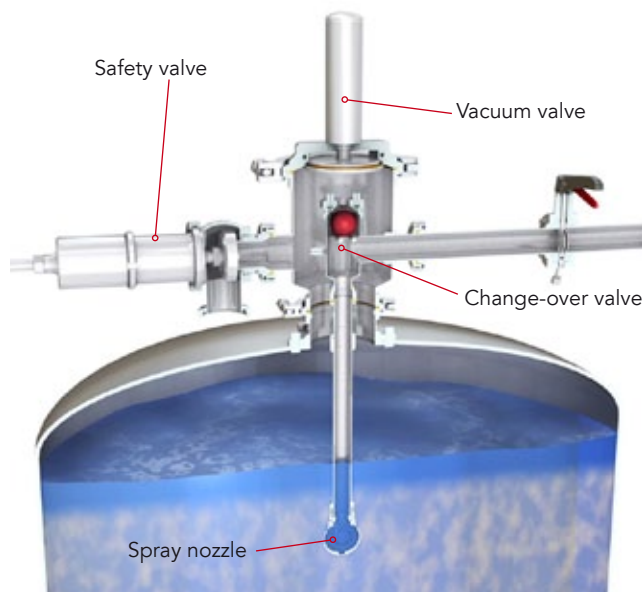

Tank dome fitting TDAM during CO₂ recirculation



Tank dome fitting TDAM with vacuum-, safety- and change-over valve plus spray nozzle (easy to maintain special equipment version with clamp)

TECHNICAL DATA

Nominal widths:	DN 50–250
Materials:	1.4301 / AISI 304 1.4404 / AISI 316L for all product wetted parts
Spray nozzle connection:	DN 20–50
Hygiene:	Cleaning certificate TU Munich Weihenstephan
Cleaning of product area:	thanks to the integrated spraying nozzle, changer-over valve and spray holes within the fitting

Functions of the TDAM

Function

- ▶ Vacuum valve opens

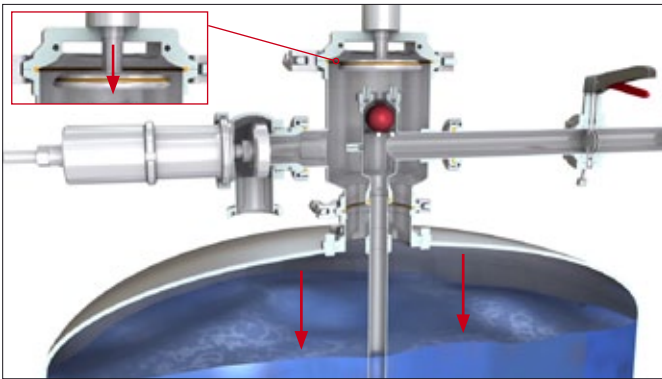

A vacuum can occur during tank discharging or due to temperature changes. When the pressure drops below the factory-designated set-pressure the vacuum valve opens, restoring the pressure equilibrium.

Function

- ▶ Change-over valve closes
- ▶ Safety valve opens

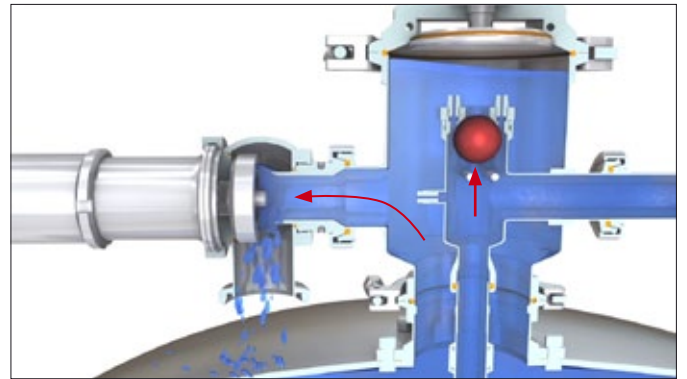

When an unintentional pressure overload occurs, the safety valve opens and releases media to relieve excess pressure. When this process is completed the safety valve closes and remains completely operational.

Function

- ▶ CO₂ recovery

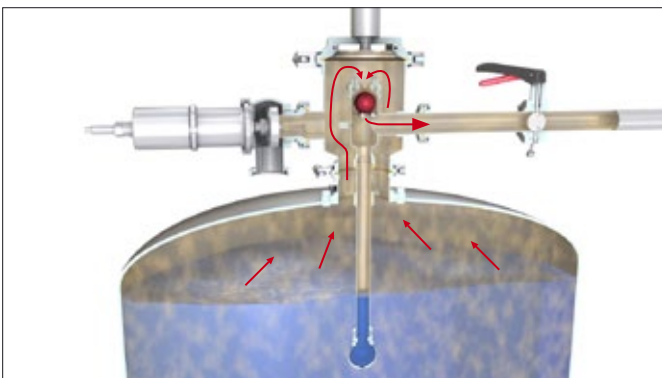

During fermentation the produced CO₂ is discharged via the changeover valve and the open butterfly valve and can be collected for recovery.

Function

- ▶ CIP-Cleaning
- ▶ CIP-Supply via the open butterfly valve



During the cleaning process the changeover valve closes and directs the CIP-medium into the tank through the cleaning device. The product-contacting internal surfaces of the TDAM and attached components are cleaned by additional static spray nozzles.

Aseptic Sample Valve

Contamination-proof sampling

KIESELMANN aseptic sampling valves provide best functionality combined with a smooth and ergonomically optimized operability. This progressive design is based on different functional modules, which can be assembled individually or in combination. Available as a simple manually operated valve up to a fully automated assembly, the modular design offers a total assortment of approx. 5000 configurations to be set up for a broad range of applications and customer specific requirements. Moreover, later setup changes or functional add-ons are feasible, just by replacing or adding functional modules.

Basic configurations

- ▶ Manual actuation (automatic closing)
- ▶ Manual actuation (self-locking)
- ▶ Pneumatic actuation
- ▶ Pneumatic/manual actuation

Options

- ▶ Position sensor
- ▶ Control head
- ▶ Manual actuated steam valve (SIP)
- ▶ Pneumatic actuated steam valve (SIP)

























TECHNICAL DATA

Sizes:	DN 25–150 (product pipe) 1½"–4" (product pipe) Tank fittings
Materials product wetted: not product wetted:	1.4404 / AISI 316L 1.4301 / AISI 304
Seal materials:	PTFE-FTM (bellow seal)
Product pressure:	max. 10 bar (liquids)
Operating temperature:	max. 90° C applicable for CIP/SIP up to 140° C
Tank & pipeline connections:	- In-line clamp connection - Pipe T-piece DN 25–150/1½"–4" - Tank welding neck - DN 25 welding neck
Product outlet & rinsing connection:	- DN 10 - G ¾ - Clip-on - manual/pneumatic steam valve
Actuations:	- manual (spring-loaded) - manual (self-locking) - pneumatic - pneumatic & manual
Automation:	- End position feedback via inductive sensor - Control head
Control air:	4 to 6 bar

Aseptic Sample Valve

Overview of the possible version

Mounted on top/Automation 3 possibilities			
			
Seal ring	End position feedback	Control head	
Actuations 4 possibilities			
			
Manual (spring-loaded) with seal ring only	Manual (self-locking) with seal ring only	Pneumatic & manual spring to close only	Pneumatic
Housing connections 17 possibilities			
			
Inline	T-pieces (14 variants: DN 25 – 150 and 1½" – 4")	Tank welding neck	Welding neck DN 25
Outlets 4 possibilities			
			
Screw sockets	Pipe DN 10	Screw socket with blind nut	Clip-on
Rinsing connections 9 possibilities			
without rinsing connection			
	Screw socket	Pipe DN 10	Screw socket with blind nut
			
Manual steam valve	Pneumatic steam valve	Pneumatic steam valve with end position feedback	Pneumatic steam valve with control head

For your Advantage – The FLUID PROCESS GROUP

KIESELMANN bundles by participation in companies the authority in different parts of plant engineering and component production within the FLUID PROCESS GROUP. This network of independent companies allows to offer and produce complex projects as a general contractor via partner companies, without the common practicing surcharges.



Paul-Kieselmann-Str. 4–10 · 75438 Knittlingen · Germany
Phone +49 (0)7043 371-0 · Fax +49 (0)7043 371-125
www.kieselmann.com · info@kieselmann.de



KIESELMANN GmbH
Innovative, reliable valves
Process components
Beverage pipes
Units



KIESELMANN Anlagenbau GmbH
Planning and construction of plants
CIP plants
Flash pasteurisers
Pigging technology
Process automation



Ferdinand-von-Steinbeis-Ring 31 · 75447 Sternefels · Germany
Phone +49 (0)7045 20498-0 · Fax +49 (0)7045 20498-90
www.aquaduna.com · info@aquaduna.com



AquaDuna GmbH & Co KG
Cleaning technology
Process automation
Mechatronics
Medical technology



Lautlinger Weg 3 · 70567 Stuttgart (Möhringen) · Germany
Phone +49 (0)711 7 67 26 60 · Fax +49 (0)711 7 67 26 69
www.va-group.de · info@va-group.de



VA Food Processing GmbH
Planning and construction of plants for
food and dairy technology
Diaphragm filtration
Process automation



Rötestraße 19 · 74321 Bietigheim-Bissingen · Germany
Phone +49 (0)71 425 81-0 · Fax +49(0)71 425 81-99
www.rieger-behaelterbau.de · info@rieger-behaelterbau.de



RIEGER Behälterbau GmbH
Stainless steel tanks
Unit construction
Agitator tanks
Total juice extractor



www.kieselmann.com